

Declaration

1. The manual is designed for the usage of EZ400PRO, applying to EZ400PRO automotive diagnosis platform.

No part of this manual allowed to be reproduced, stored in a retrieval system or transmitted, in any form or by any means (electronic, mechanical, photocopying, recording, or otherwise), without the prior written permission of Xtool.

2. This electronic control system diagnostic unit is for professional vehicle maintenance technicians. It has some reliability, but it can not rule out vehicle damage and loss, caused by customer technical problems, vehicle problems or other factors, for these reasons, users need to take risks.

3. Use the device only as described in this manual. The user will be responsible solely for the after-effects of violating the laws and regulations caused by using the product or its data information, Xtool will not bear any legal responsibility for that.

4. Xtool shall not be liable for any incidental or consequential damages or for any economic consequential damages arising from the accidents of individual users and the third parties, misuse or abuse of the device, unauthorized change or repair of the device, or the failure made by the user not to use the product according to the manual.

5. All information, specifications and illustrations in this manual are based on the latest configurations and functions available at the time of printing. Xtool reserves the right to make changes at any time without notice.

6. **XTOOL** is the registered trademark of Shenzhen Xtooltech Co., Ltd.

7. In the countries that the trademarks, service marks, domain names, logos and the name of the company do not be registered, Xtool claims that it still reserves the ownership of the unregistered trademarks, service marks, domain names, logos and the company name. All other marks for the other products and the company's name mentioned in the manual still belong to the original registered company. Without written permission from the trademark holder, no one shall use the trademarks, service marks, domain names, logos and company name of Xtool or other companies mentioned

8. Please visit <http://www.xtooltech.com> for more information about EZ400PRO.

9. Xtool reserves the right for the final interpretation of this manual content.

CONTENT

CHAPTER I About EZ400PRO.....	3
1. Appearance.....	3
1.1. Front View.....	3
1.2. Back View.....	3
2. Layout of EZ400PRO Tablet.....	4
2.1. Top View of EZ400PRO Tablet.....	错误！未定义书签。
3. Layout of VCI Box.....	错误！未定义书签。
4. EZ400PRO Technical Parameters.....	4
CHAPTER II How to use EZ400PRO.....	5
1. EZ400PRO Activation.....	5
1.1. Please activate EZ400PRO before you use it to test vehicles.....	5
1.2. Connect to WiFi first.....	5
2. EZ400PRO Main Interface and Functional Buttons Descriptions.....	6
2.1. Main Interface.....	6
2.2. Sub-menus and Function Buttons.....	6
2.3. Toolbar Function Buttons.....	7
3. Vehicle Connection Diagnosis.....	7
3.1. Vehicle Connection Test.....	7
3.2. Precautions Before Use.....	7
4. Diagnosis.....	8
4.1. Menu Options.....	8
4.2. Test Functions.....	9
4.3. Read ECU.....	10
4.4. Read DTCs.....	11
4.5. Clear DTCs.....	12
4.6. Read Live Data.....	12
4.7. Special Functions.....	14
4.8. Actuation/Active/Components Test.....	15
5. Settings.....	16
6. Diagnostic Reports.....	17
6.1. PDF Files:.....	17
6.2. Pictures:.....	18
6.3. Data Playback:.....	18
7. UPDATE.....	18
8. Xtool Cloud System(Coming soon).....	19
9. Remote Access.....	19
CHAPTER III Diagnostic Link Connectors of Different Vehicle Models.....	20
1. Diagnostic Link Connectors Diagram of Some Vehicle Models.....	20
2. Location Diagram of Vehicle Diagnostic Link Connectors.....	23
3. Diagnostic Link Connectors Terminal Definition and Communication Protocols.....	24
3.1. Standard OBDII Diagnostic Link Connector.....	24

CHAPTER I About EZ400PRO

1. Appearance

1.1. Front View



1.2. Back View

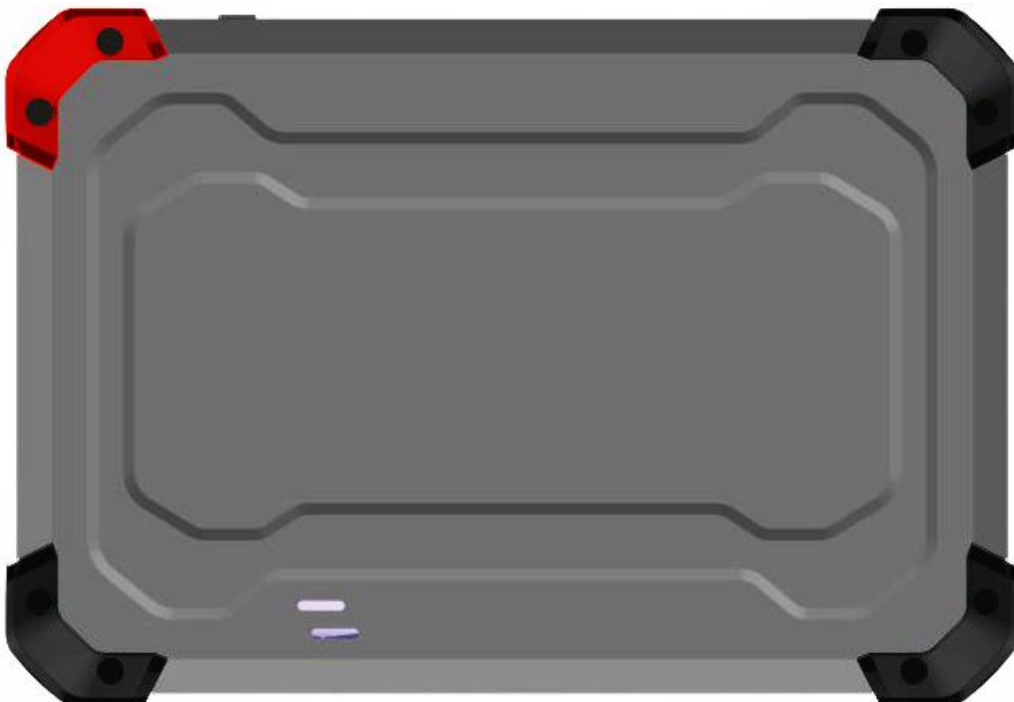

2. Top View of EZ400PRO Tablet

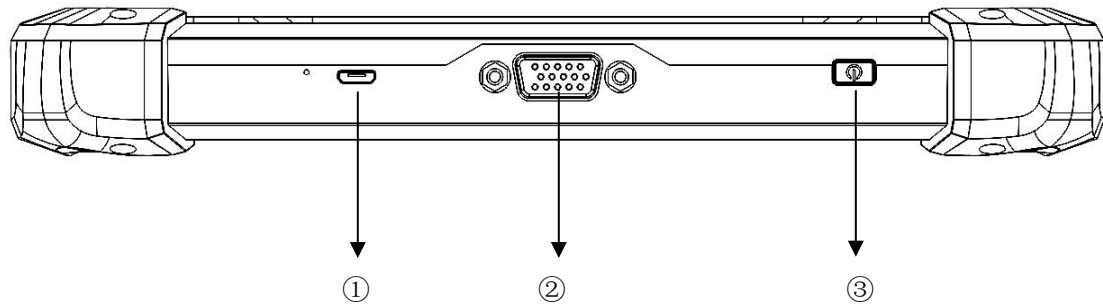

- ① MicroUSB: Battery charge or data synchronization with PC
- ② DB15 Port: Supports wired connection with car by the cable
- ③ Power Button: Power on or power off

4. EZ400PRO Technical Parameters

Operating System: Android

Processor: Quad-core 1.6GHz Processor

Memory: 1G RAM, 16G FLASH

Display: 7.0 inch touch screen with 1024×600 resolution

Sensors: Gravity Sensor, Ambient Light Sensor

Audio Input/Output: Microphone, Dual Speakers, 4-Band 3.5 mm stereo/standard headset jack

Power and Battery: 4000mAh, 3.7V lithium-polymer battery

Power Voltage: 5V

Power Consumption: 8W

Operating Temperature: -20 to 50°C (-4 to 126°F)

Humidity: <90%

Dimension (L*W*H): 218*150*29mm

CHAPTER II How to use EZ400PRO

1. EZ400PRO Activation

1.1. Please activate EZ400PRO before you use it to test vehicles.

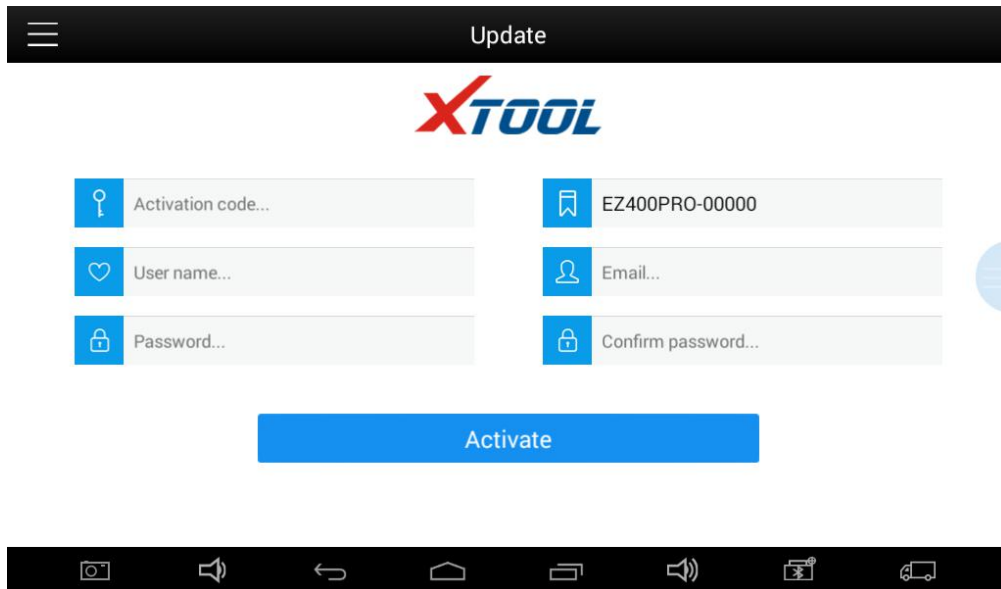

1.2. **Connect to WiFi first.** Input activation code, product serial number (each device will have a serial number and activation code), nickname (workshop's name or user's nickname), login account (can be your email address or cell phone number) and password, then system will remember it. Activation only needs to be done for the first time, and you never have to do it again. The diagnostic interface will come up after activation.

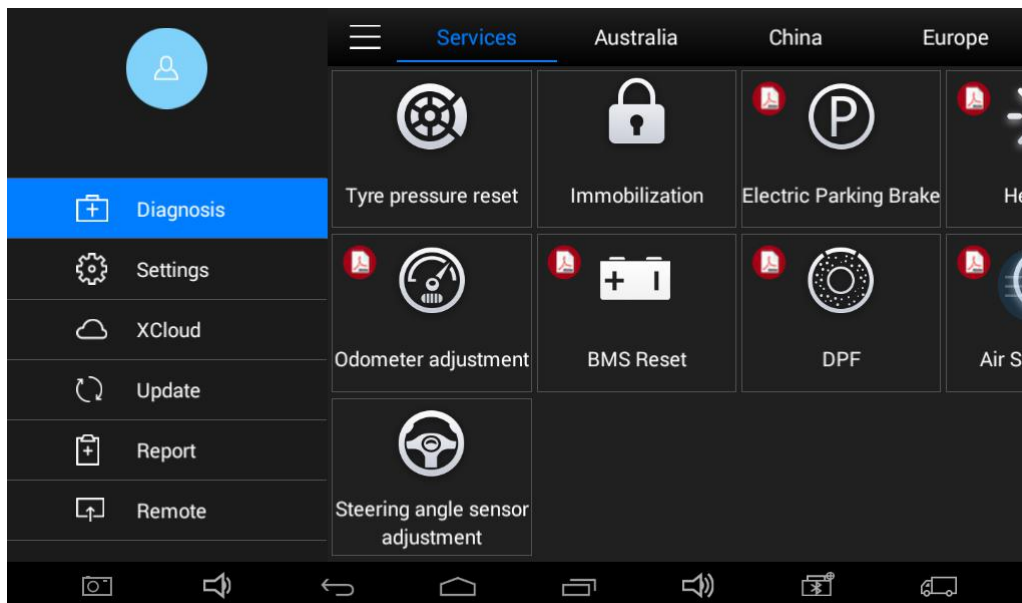

2. EZ400PRO Main Interface and Functional Buttons Descriptions

2.1. Main Interface

Tap on EZ400PRO application, the main interface and sub-menus shows up as below. ▼

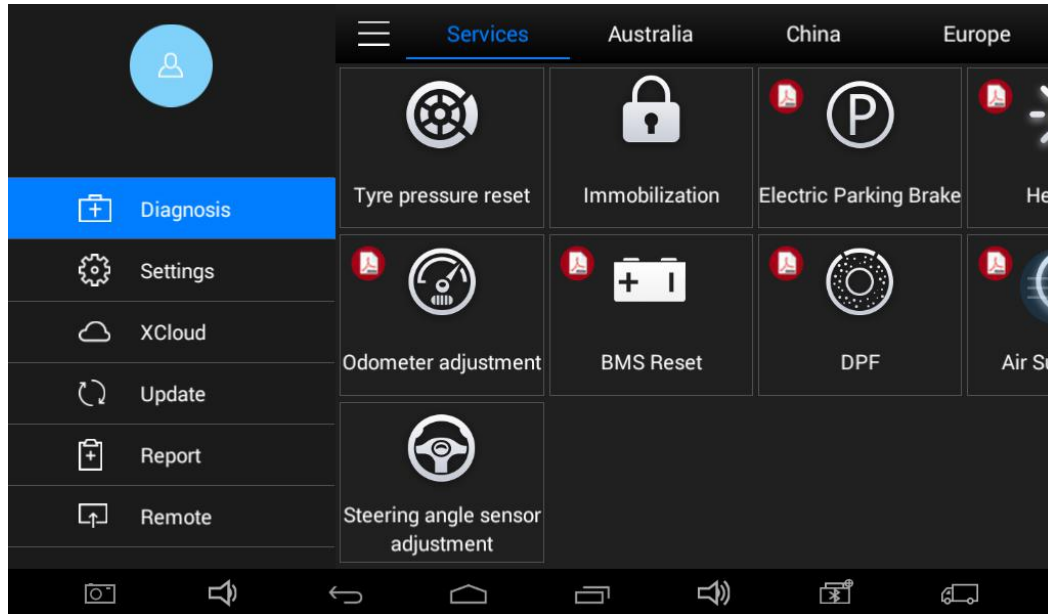

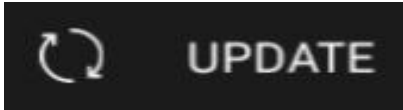

2.2. Sub-menus and Function Buttons

Function Buttons	Descriptions
	Configures EZ400PRO Tablet to perform as diagnosis system. It can read diagnostic information, view live data, perform actuation tests and special functions and etc.
	Users can view all the diagnostic reports and diagnostic data generated in the process of diagnosis.
	Selecting “Settings”, users can make the language setting and other system related settings.
	Online Communication Platform.(Coming soon)
	Provide remote assistance

	<p>Click UPDATE after it connects with internet, then you can download the latest diagnostic software directly.</p>
---	---

2.3. Toolbar Function Buttons

Function Buttons	Descriptions
	Returns to previous interface
	Returns to the main interface of Android System
	Shows recently used applications

3. Vehicle Connection Diagnosis

3.1. Vehicle Connection Test

3.1.1. Wired Connection ①→②→③→④

a. Connect cables and **EZ400PRO** in following order: ①→②→③→④

b. Switch on the ignition and turn on EZ400PRO tablet, then tap on EZ400PRO application to test vehicles. (Shown as follows)

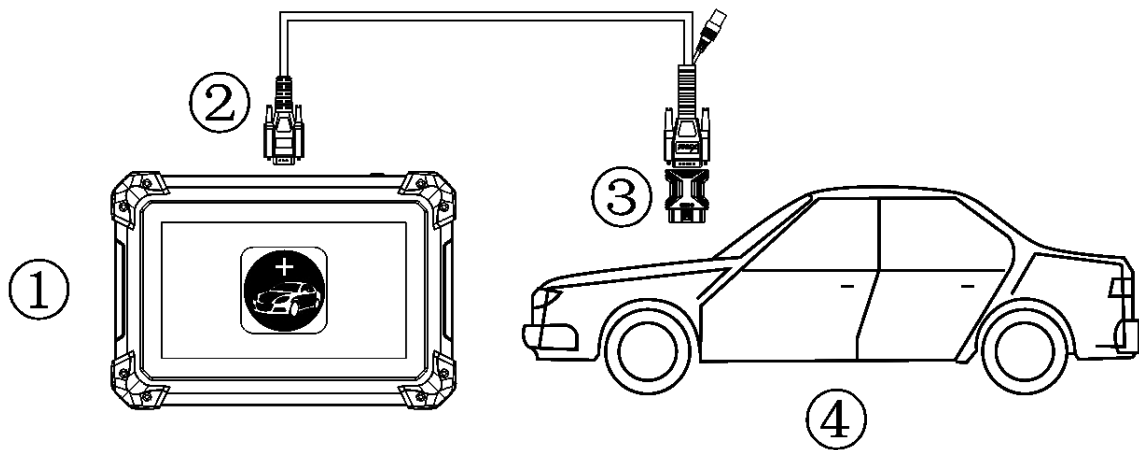

① EZ400PRO Mainframe ② Main Test Cable ③ OBD II-16 ④ Vehicle

3.2. Precautions Before Use

3.2.1. The vehicle power supply has to meet the normal voltage limits DC4.8V---5V.

3.2.2. When pull and plug test wire harness, users should pinch the front-end of the wire harness to pull and plug, not pull the middle section of the wire harness. Users should check the corresponding direction of the port and plug in horizontally when they plug the wire harness, instead of inserting in an oblique way, which may damage the terminal.

3.2.3. When taking some special functions tests, users are required to operate the device according to operating instructions. For vehicle, it has to strictly meet the requirements, for example, the conditions that some vehicle models need to be reached are as follows: engine temperature 80°C/105°C, turn off the loads (such as headlights, air-conditioner, etc.), put accelerator pedal in released position, etc.

3.2.4. The ECU for Chinese domestic vehicle models are relatively disorderly, so when users meet conditions, such as the car can not be tested or the test data is wrong, they should consider whether the selected menu corresponds to the tested electronic control system, or they can find the car ECU and select the right menu according to the model number on the ECU label.

3.2.5. If users can not find the tested vehicle model or electronic control system in EZ400PRO test menu, they may need to update the software or consult Xtool technical service department

3.2.6. Banned to have connection test by using harness not from Xtool to avoid unnecessary losses.

3.2.7. Banned to power off directly in the communication between EZ400PRO and vehicle. Users should cancel the task and return to the main interface, then power off.

3.2.8. The device should be put and lifted slightly to avoid collision when using EZ400PRO. When click the screen, touch it gently to guarantee the service life of the touch screen.

3.2.9. During long period of non-use, please disconnect the power and turn it off.

4. Diagnosis

4.1. Menu Options

4.1.1. After EZ400PRO tablet connected to vehicle via main cable, diagnosis can be performed now. The diagnostic interface comes up as below.

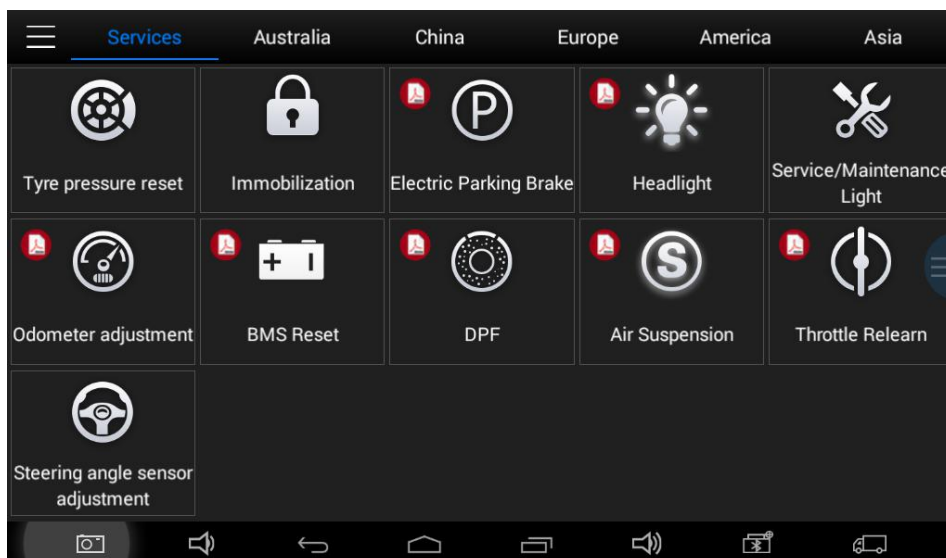

4.1.2. Users can choose menu based on their actual needs: selection for **Europe** means

entering European cars menu, selection for **Asia** means entering Asian cars menu, selection for **America** means entering American cars menu, selection for **China** means entering Chinese cars menu. Users also can input vehicle model to search.

4.2. Test Functions

4.2.1. Take **Volkswagen car** for example, select **Diagnosis**, then select **Europe Car**, users can see **Volkswagen's** logo. If the logo has not been seen, please swipe up and down or enter the car model to research.



Different vehicles have slight different menus.

Common main function menu includes the following options:

Read ECU: this function is to read ECU version information, which is the equivalent of “System Identification” or “System Information” in some electronic control systems, all mean to read ECU related software and hardware versions, models and production date of diesel engine, part number, etc. It is convenient for us to make record in the maintenance process, and it also makes later date feedback and management easier.

Read DTCs: read trouble codes stored in ECU.

Clear DTCs: clear current and historical trouble codes memory in ECU, under the premise that all the troubles are eliminated. The trouble codes can not be erased without eliminating all the troubles, which will cause the diagnostic tool always reading the trouble code because the code will always be saved in ECU. Suggestion: users should better not to clear trouble codes, we need record the trouble details after reading code, which is provided as reference for maintenance. After dealing with troubles, there will be no trouble code when we re-read.



Read Live Data: that is to read the parameters of running engine, such as oil pressure, temperature, engine speed, fuel oil temperature, coolant temperature, intake air temperature, etc. Based on these parameters, we can judge directly where the problem lies, which helps to narrow the scope in maintenance. For some vehicles, during their actual operation, the problems such as performance characteristics offset, sensitivity reduction, can be judged in

live data. This function needs us very familiar with engine parameters, for instance, when idle speed is 800RPM or 750RPM, coolant operating temperature is between 80 ~ 105°C, what are the operating voltage and time of each sensor and actuator?

Special Functions: depends on vehicle models.

Actuation/Active/ Components Test: mainly to judge whether these actuating components of engine are working properly.

4.2.2. Toolbar function buttons descriptions

Function Buttons	Descriptions
	Returns to previous interface
	Print testing data
	Click it to record the data, click again to send your feedbacks to XTOOL after service center

Record data feedback button as shown below, showing diagnostic software version and various information in the diagnostic process.

Cancel
Feedback
Send

Problem description

Vehicle Info

System Diagnosis

Software Info









EN_PS_VW_V9.29

User Info

Contacts

Tel.

Email

4.3. Read ECU

This function is to read ECU version information, which is the equivalent of “System Identification” or “System Information” in some electronic control systems, all mean to read ECU related software and hardware versions, shown as below.

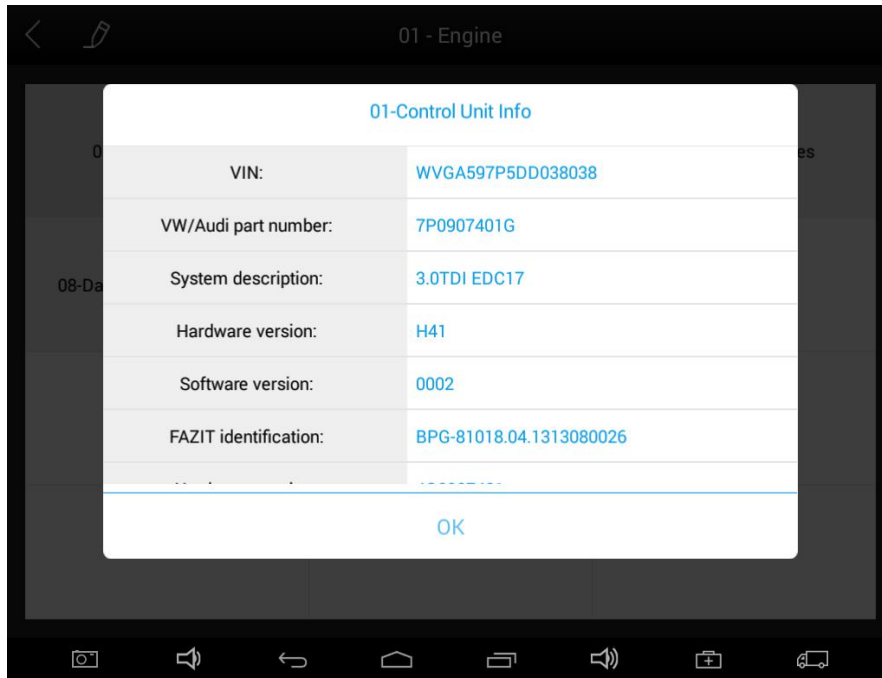

4.4. Read DTCs

Select **Read Trouble Codes** to read trouble codes stored in ECU. Screen will show the trouble code and its definition when read the trouble codes, shown as below.

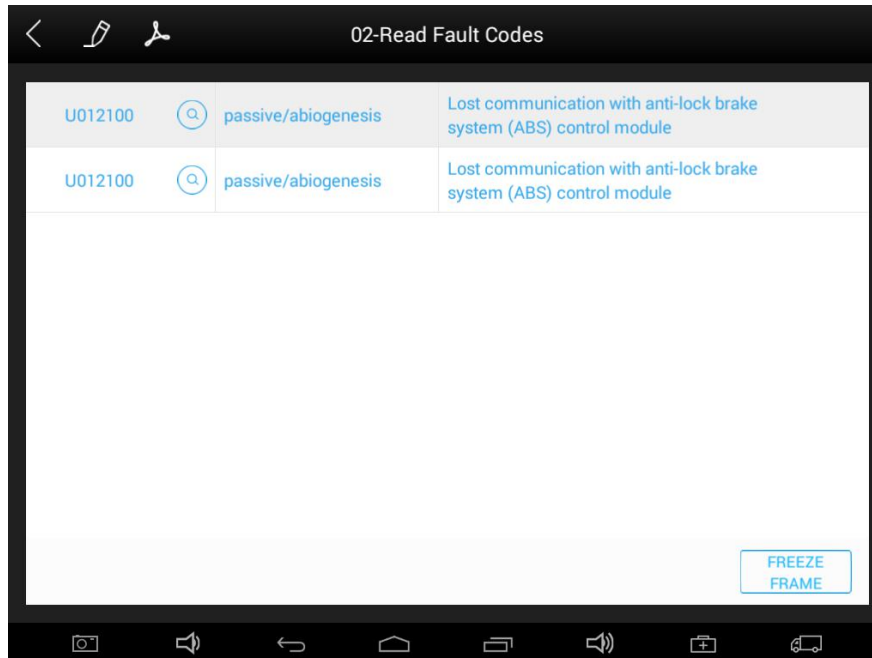

Tip: In the process of diagnosis, if the device shows “System is OK” or “No Trouble Code”, it means there is no related trouble code stored in ECU or some troubles are not under the control of ECU, most of these troubles are mechanical system troubles or executive circuit troubles, it is also possible that signal of the sensor may bias within limits, which can be judged in Live Data.

4.5. Clear DTCs

4.5.1. Return to the previous step, select **Clear DTCs** to clear current and historical trouble codes memory in ECU. Performing this function will clear all the current and historical trouble codes. Make sure whether the trouble codes have been recorded before clearing, shown as below.

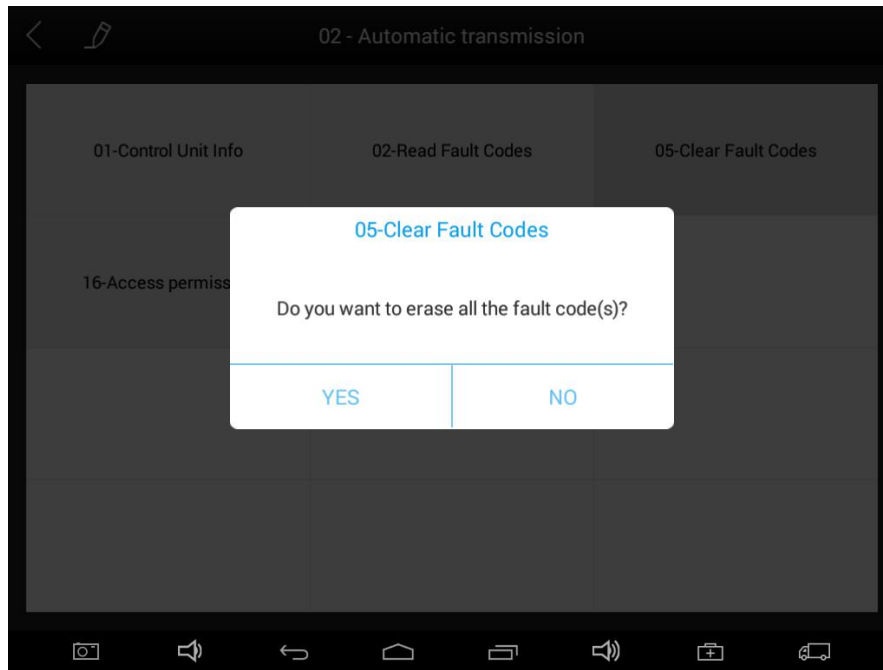

4.5.2. Click **YES** to make clear confirmation, if the communication is normal, it will show "**Trouble Codes Successfully Cleared**" or "**Trouble Codes Cleared**". Generally, users need re-read trouble codes after cleaning them to confirm whether the trouble codes have been cleared.

4.6. Read Live Data

Auto ECUs send out operating parameters and working status of various components in the form of Electronic Signal, here Electronic Signal refers to Live Data. Common Engine Live Data includes Engine Speed, Throttle Position Sensor Voltage, Oxygen Sensor Voltage, Coolant Temperature, Spark Advance Angle, Idle Speed Switch State, Intake Air Temperature, Intake Pressure, etc.

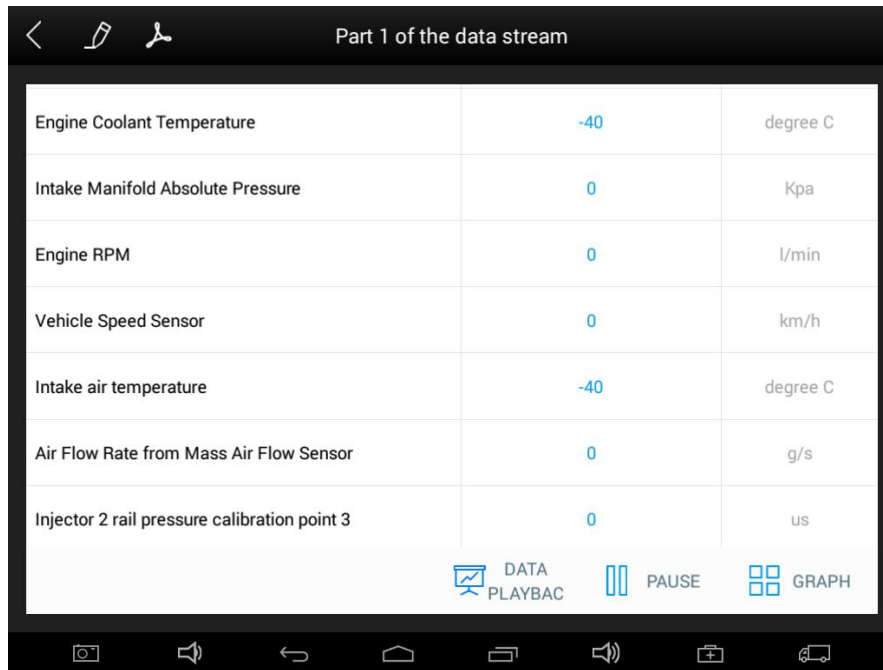

Tips: Live Data is the important function for maintenance technicians to further diagnose the troubles. This function needs maintenance technicians very familiar with sensor data of each system, control signals and control modes, all which are the indispensable basis of using Live Data function for maintenance technicians. (The following is test conditions and typical values of common live data)

Test Items	Unit	Normal Data	Test Conditions & Typical Values
1.Engine Speed	rpm	0-6000	Engine warmed-up: 750-850rpm
2.Engine Coolant Temperature	℃	-40-150	Engine warmed-up: 85-95℃
3.Throttle Percentage		0-100	Throttle closed:0%, Throttle wide-open: > 85
4.Injecting Pulse Width	ms	0-15	Engine warmed-up: 3.5-4.5ms
5.Intake Air Temperature	℃	-40-150	Show value a little higher than ambient temperature
6.Battery Voltage	v	0-15	Idle speed: 1.5-13.5V
7.Injection closed-loop correction		0-1.99	
8.Load	ms	0-15	
9. Angle of Ignition Advance	℃	0-50	Engine warmed-up: 5-15 ℃ variations
10.Air Intake	kg/h	0-255	Engine not started: 0
11.Intake Pressure	hpa	0-1013	Engine not started: 1013hpa
12. Idle-speed Adjustment Status		0-255	
13.Oxygen Sensor	mv	0-1000	Engine warmed-up: 50-960mv

			variations
--	--	--	------------

Display Modes

There are two modes to view Live Data, users can choose optimum mode according their own needs and different parameter types.

Dashboard Mode: Display parameters in the form of simulating instrument graphics.

Graph Mode: Display parameters in the form of graph.



Commanded EGR[%]
0



EGR Error[%]
-100



Distance traveled since DTCs cleared[km]
0



Barometric Pressure[Kpa]
0

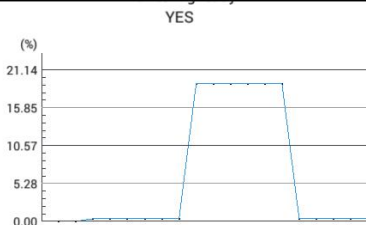

Calculated LOAD Value
0.39

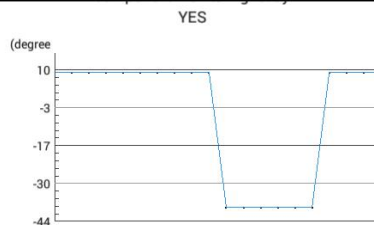

Engine Coolant Temperature
9

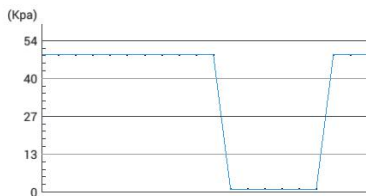

Intake Manifold Absolute Pressure
49

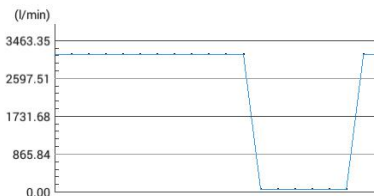

Engine RPM
3148.50

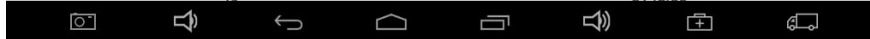

4.7. Special Functions

More special function will be found in different vehicle models.



4.8. Actuation/Ative/Components Test

Test Conditions: Ignition on engine off

If engine started or rotation speed signal recognized, actuating component diagnosing will be interrupted.

In the process of actuating components diagnosis, single component will always be in the trigger status until the next component being activated.

Before repeating actuating components diagnosis, users should start engine in short-time, or turn ignition off for 2 seconds.

Actuating components can be checked by hearing or touching.

In the process of all actuating components diagnosis, electric fuel pump is always working.

10 minutes later, actuating components diagnosing is terminated.

Actuating Component: it is responsible for executing various instructions issued by ECU, which is the instruction completer.

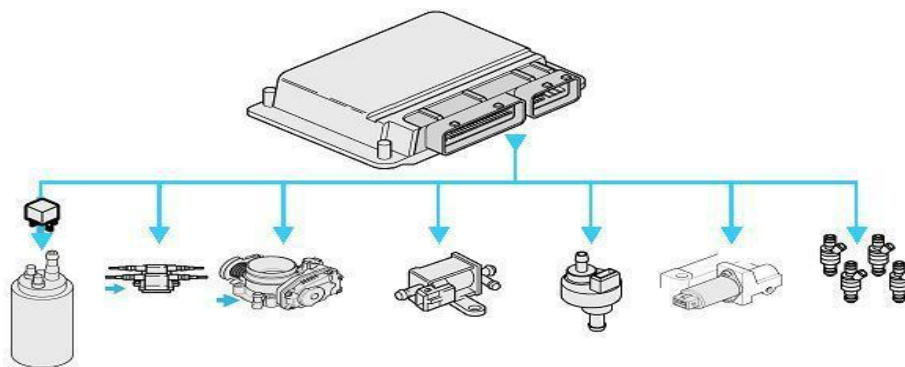

4.8.1. Return to **Dynamic Diagnostic Data**, enter **Actuating Components Test** and it will

show the menu of the actuating components that carry out action test, shown as below.



Tip: **Actuating Components Test** performs function tests for parts of system actuating components. When performing this function, the diagnostic tool will take action test by simulating ECU signal to judge whether the actuating components or circuits are good. Return to Dynamic Diagnostic Data, enter Actuating Components Test and it will show the menu of the actuating components that carry out action test.

5.Settings

Select enter **Settings**; users can set the language, unit and other system related options:
 Languages: select the language. Please tick the needed option from multi-language options on the right.

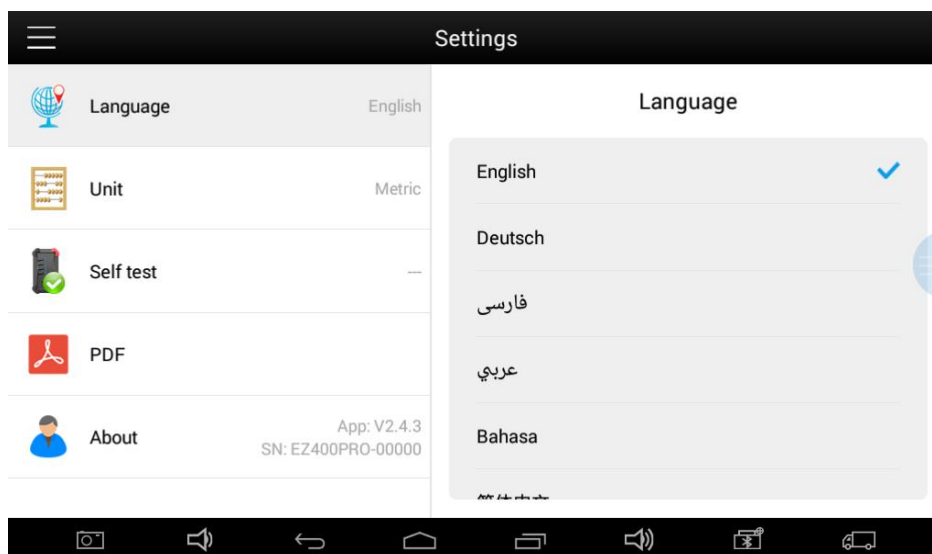

Units: Select unit of measurement. Users can tick Metric or English measurement.

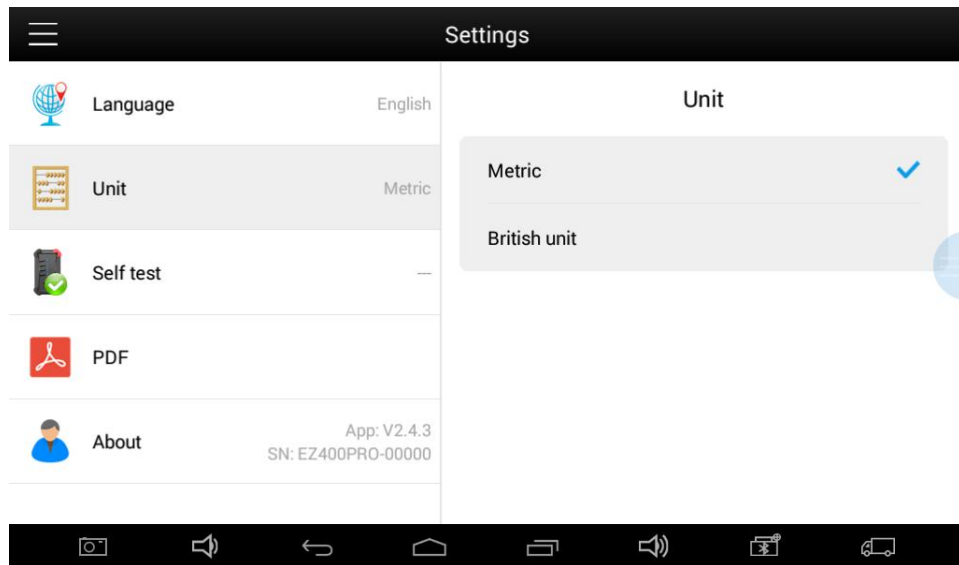

System Settings: Android system setup, such as wireless, audio frequency, light sensation, etc.

6. Diagnostic Reports

Diagnostic Reports is for checking the saved files, such as the report of Live Data or Trouble Codes or pictures generating in the process of diagnosis, users also can know what cars have been tested. It includes three parts: PDF Files, Pictures and Data Playback.

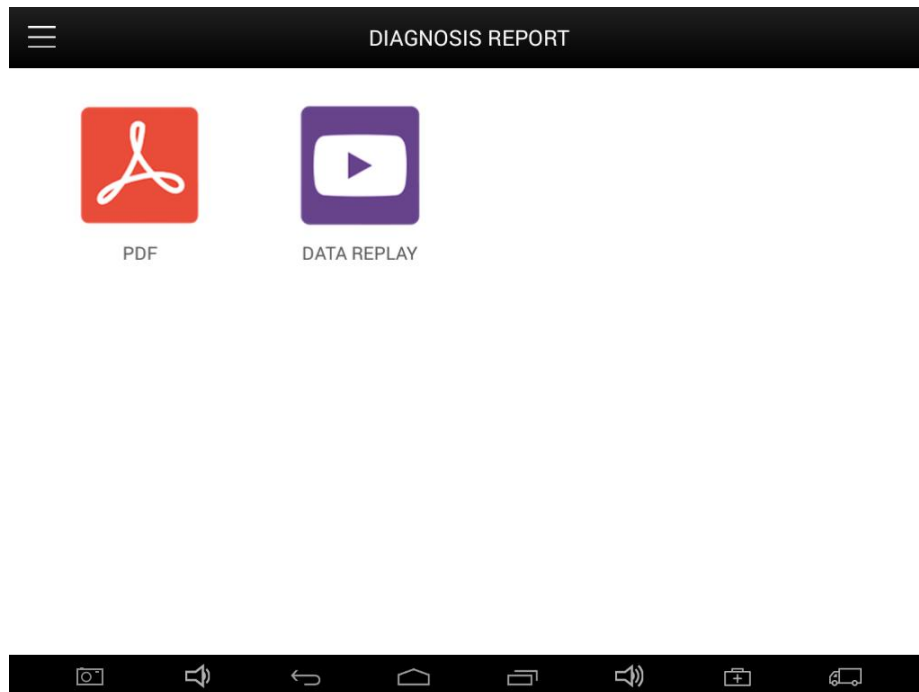

6.1. PDF Files:

PDF files are the diagnostic reports of Live Data or Trouble Codes in the process of diagnosis. Entering **PDF** can check various diagnostic reports.



6.2. Pictures:

Pictures are all the screen capture files in the diagnosis process.

6.3. Data Playback:

Data Playback can check what cars have been tested and play recorded Live Data & freeze frame.

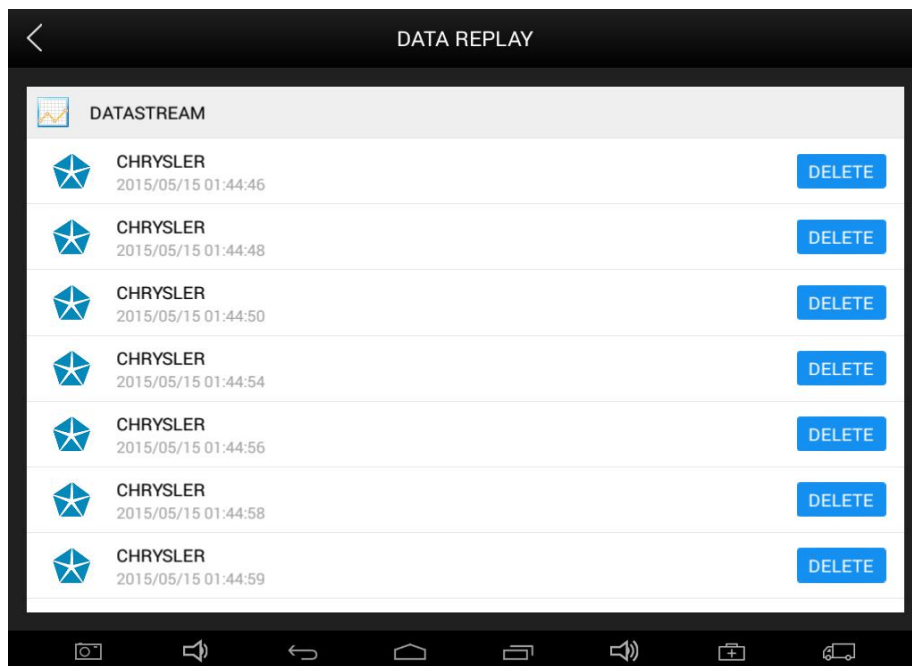

7. UPDATE

EZ400PRO doesn't need insert a card for updating, users only need to tap on EZ400PRO

application and click UPDATE , shown as follows.

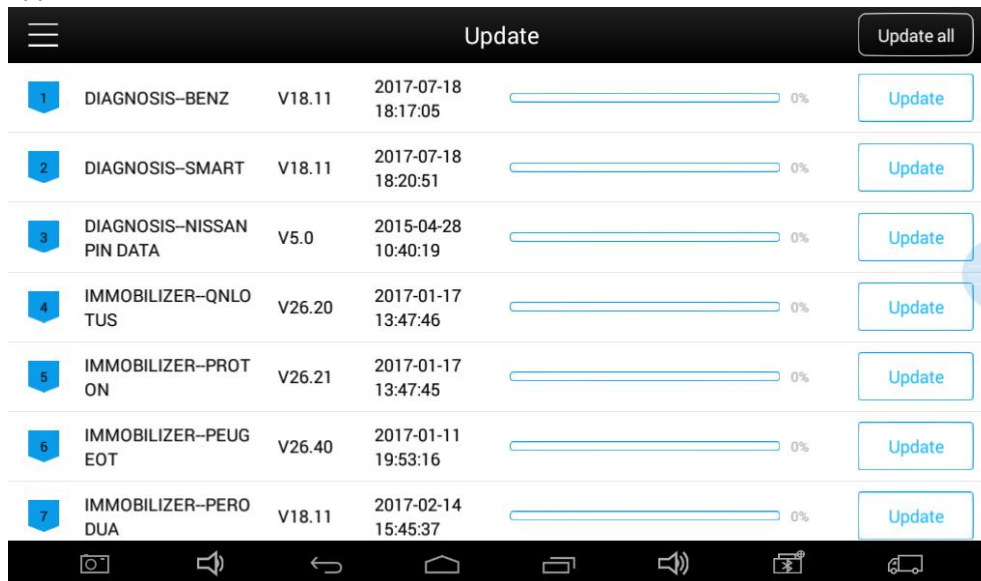

8. Xtool Cloud System(Coming soon)

All the auto maintenance technicians who use our products can not only look up the maintenance information that we put on our cloud service platform conveniently, and combine the diagnosis result to query, and communicate with other Xtool users in our forum, but can also access various online databases of maintenance and diagnostic skills and vehicle maintenance plans.

9. Remote Access

In the maintenance process, when maintenance technicians encounter problems and don't know how to solve, they can open this application and ask for remote assistance.

How to get remote assistance from Xtool Technical Assistance Center

- a. Open EZ300
- b. Click **Remote Access** and open **TeamViewer** interface. Generate and display device ID.
- c. Your partner also need download and install **TeamViewer** complete version.
- d. Enter your partner's **TeamViewer** ID and send remote request. The system will pop up a window and allow your partner to control yours, and then remote control begins.

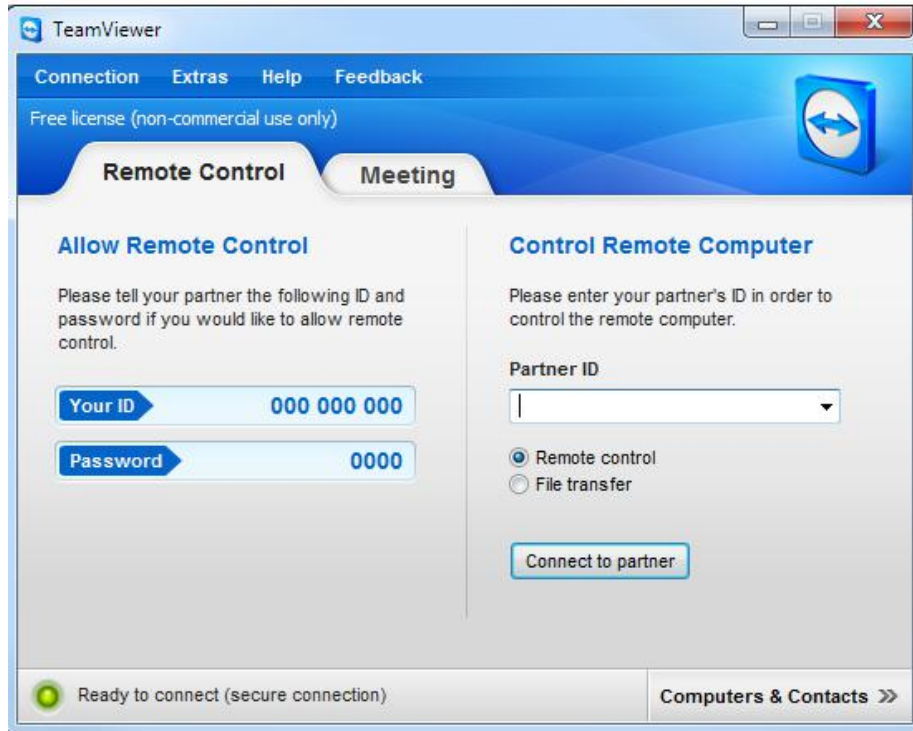

CHAPTER III Diagnostic Link Connectors of Different Vehicle Models

1. Diagnostic Link Connectors Diagram of Some Vehicle Models



*AUDI A6: the OBD plug is on the lower left side of the dashboard, we can use SMART OBDII-16 connector.



*VW Bollywood 1.8: the OBD plug is below the console,we can use SMART OBDII-16 connector.



*Benz S320,220 Chassis: the OBD plug is below the dashboard, we can use SMART OBDII-16 connector.

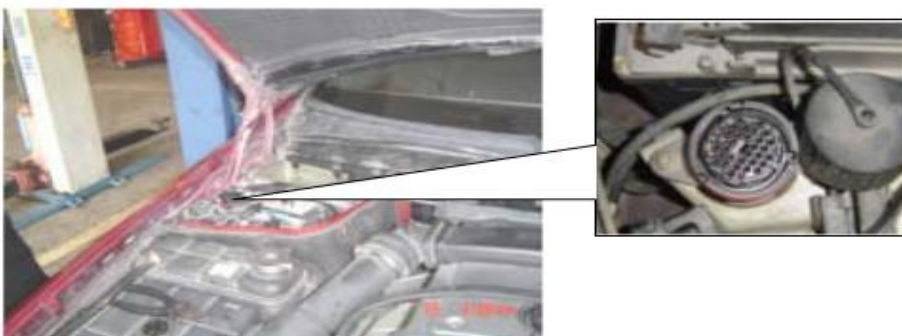

*Benz C180: the OBD plug is in the right back side of engine room,we can use Benz-38 connector.



*Benz 300SEL 140 chassis: the OBD plug is in the right side of the engine room,we can use Benz-38 connector.

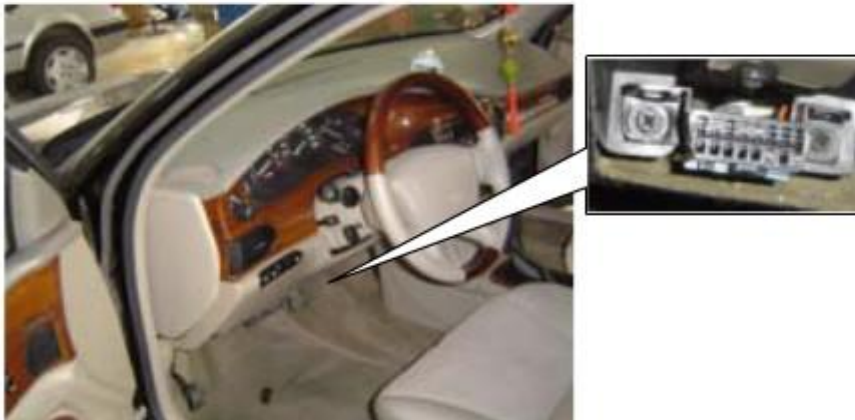

*GM Buick: the OBD plug is below the dashboard,we can use SMART OBDII-16 connector.



*GM Buick GL8 : the OBD plug is below the dashboard,we can use SMART OBDII-16 connector.

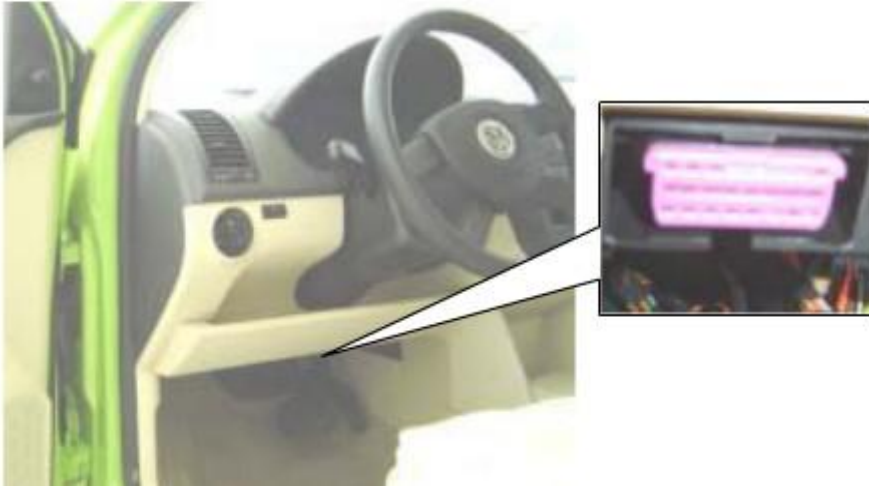

*VW POLO: the OBD plug is below the dashboard; we can use SMART OBDII-16 connector.



*BMW 735i: the OBD plug is in the left side of the engine room, we can use BMW-20 connector.

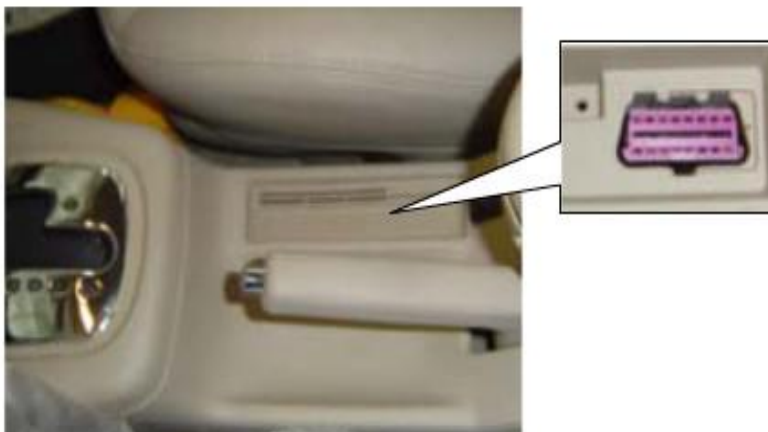

*VW Passat B5: the OBD plug is behind the gearlever and beside the parking brake lever. It will appear when take away the cover. we can use SMART OBDII-16 connector.

2. Location Diagram of Vehicle Diagnostic Link Connectors

Location diagram of pick-up truck diagnostic link connectors:

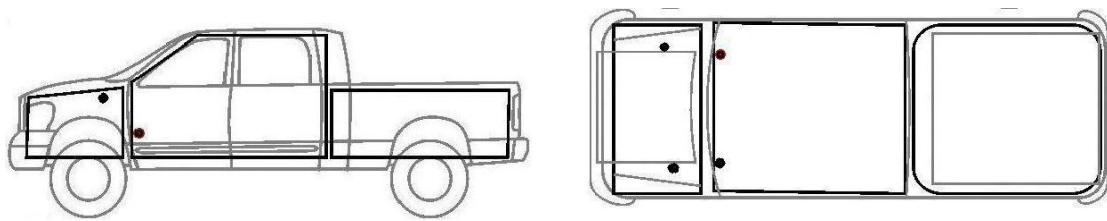

Location diagram of utility vehicles diagnostic link connectors:

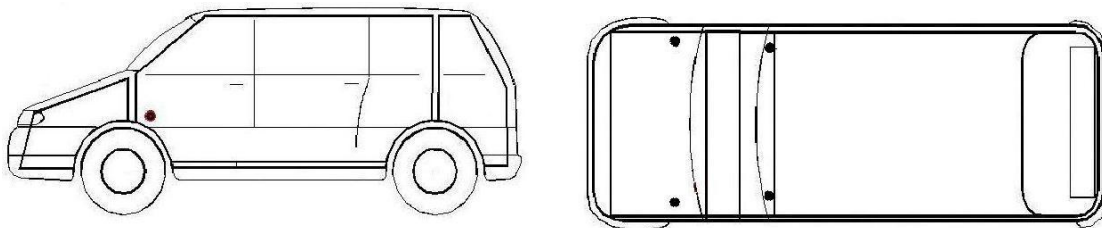

Link diagram of small car diagnostic link connectors:

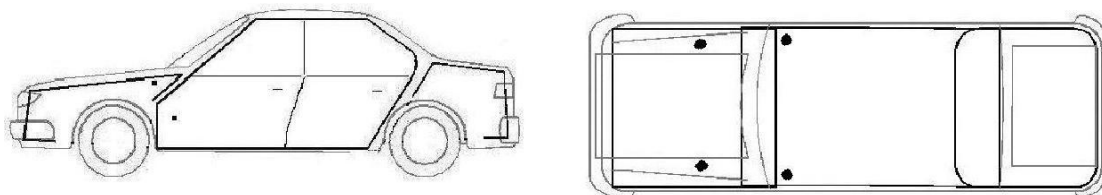

NOTE: Each vehicle manufacturer may use additional pins to diagnose a variety of systems. Not every manufacturer uses the same standard. The function on a certain pin will vary from manufacturer to manufacturer. Verify with the manufacturer.

3. Diagnostic Link Connectors Terminal Definition and Communication Protocols

3.1. Standard OBDII Diagnostic Link Connector:

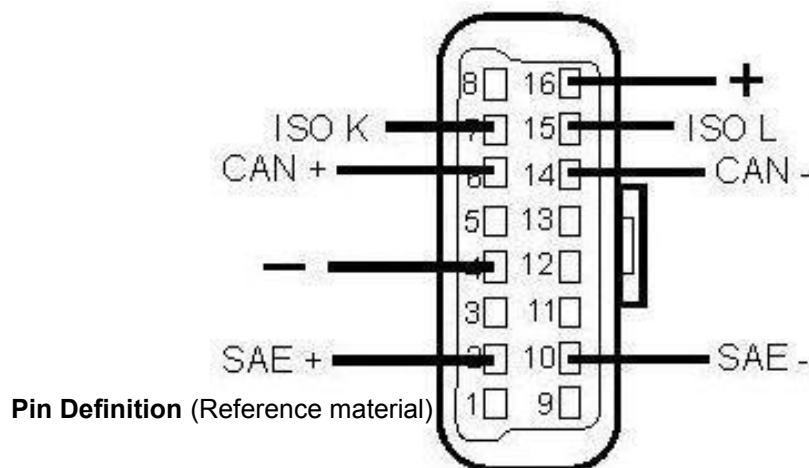

Various pin definitions as follows:

1. Manufacturer definition
2. SAE J1850 bus positive
3. Manufacturer definition
4. Bodywork site
5. Signal site
6. ISO 15765-4 defined CAN high
7. ISO9141 and ISO14230 defined K line
8. Manufacturer definition
9. Manufacturer definition
10. SAE J1850 bus negative
11. Manufacturer definition
12. Manufacturer definition
13. Manufacturer definition
14. ISO 15765-4 defined CAN low
15. ISO9141 and ISO14230 defined L line
16. Permanent positive voltage

[1] 1, 3, 8, 9, 11, 12 and 13 haven't been distribution, which can be defined by manufacturer.

[2] 2, 6, 7, 10, 14 and 15 are used for diagnostic communication. They are always won't be used at the same time according to the actually used communication may be different. Unused definitions can be defined by automakers.